

Article number: 604145034085

Description: Timing belt pulley with hub  
HTD 34 14M 85

## Measures

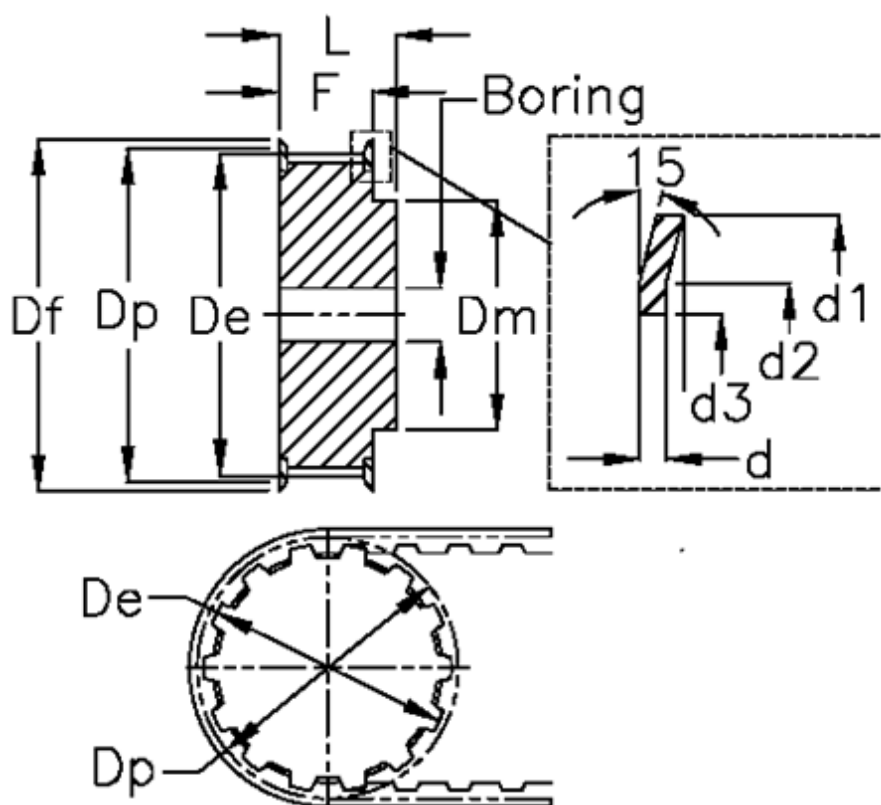

Bore = 24	Dp	= 151.52
d = 2.5	F	= 102
d1 = 160	Flange type	= F51
d2 = 148	L	= 117
d3 = 120	Tooth number	= 34
De = 148.79	Type	= 14M
Df = 160	Weight	= 11.9
Dm = 100	Width	= 85